

FEATURES

- Low switching losses
- Low V_{CEsat}
- V_{CEsat} with positive temperature coefficient
- 10 μ s short circuit capability
- Isolated copper baseplate using DBC technology

APPLICATION

- Welding Machine
- Switching Mode Power Supplies

IGBT

$V_{CES} = 1200V$
 $I_{C\ nom} = 40A / I_{CRM} = 80A$

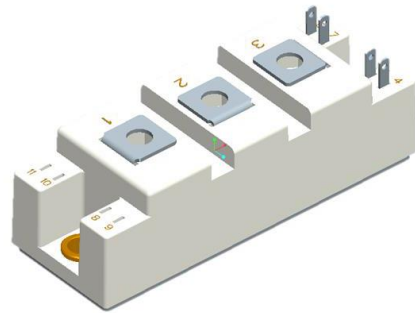

Equivalent Circuit Schematic

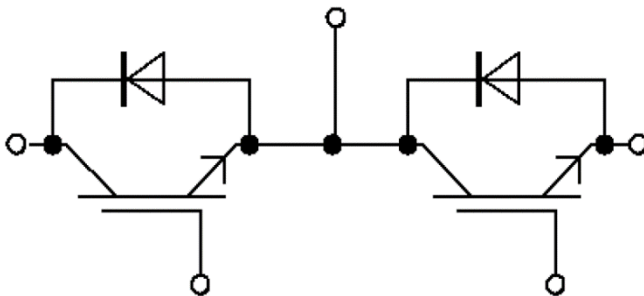

IGBT, Inverter Maximum Rated Values

Parameter	Conditions	Symbol	Values	Units
Collector-emitter voltage	$T_{vj} = 25^{\circ}\text{C}$	V_{CES}	1200	V
Continuous DC collector current	$T_c = 100^{\circ}\text{C}, T_{vj} \text{ max} = 150^{\circ}\text{C}$	$I_{C \text{ nom}}$	40	A
Repetitive peak collector current	$t_p = 1 \text{ ms}$	I_{CRM}	80	A
Total power dissipation	$T_C = 25^{\circ}\text{C}, T_{vj} \text{ max} = 150^{\circ}\text{C}$	P_{tot}	240	W
Gate-emitter peak voltage		V_{CES}	± 20	V

Characteristic Values

Parameter	Conditions	Symbol	Values			Units
			Min.	Typ.	Max.	
Collector-emitter saturation voltage	$I_C = 40 \text{ A}, V_{GE} = 15 \text{ V}$ $T_{vj} = 25^{\circ}\text{C}$ $T_{vj} = 150^{\circ}\text{C}$	$V_{CE \text{ sat}}$		1.8 2.3		V
Gate threshold voltage	$I_C = 0.25 \text{ mA}, V_{CE} = V_{GE},$ $T_{vj} = 25^{\circ}\text{C}$	V_{GEth}		5.9		V
Gate charge	$V_{GE} = -15\text{V}...+15\text{V}$	Q_G		0.25		μC
Input capacitance	$V_{CE} = 25\text{V}, V_{GE} = 0\text{V},$ $f = 1\text{MHz}$	C_{ies}		6400		pF
Output capacitance		C_{oes}		180		pF
Reverse transfer capacitance		C_{res}		90		pF
Collector-emitter cut-off current	$V_{CE} = 1200 \text{ V}, V_{GE} = 0 \text{ V},$ $T_{vj} = 25^{\circ}\text{C}$	I_{CES}			1.0	mA
Gate-emitter leakage current	$V_{CE} = 0 \text{ V}, V_{GE} = 20 \text{ V},$ $T_{vj} = 25^{\circ}\text{C}$	I_{GES}			400	nA
SC data	$V_{GE} \leq 15 \text{ V}, V_{CC} = 800 \text{ V}$ $V_{CEmax} = V_{CES} - L_{SCE} \cdot di/dt$ $t_p \leq 10 \mu\text{s}, T_{vj} = 150^{\circ}\text{C}$	I_{SC}		350		A
Thermal resistance, junction to case	per IGBT	R_{thJC}			0.52	K/W
Thermal resistance, case to heatsink	per IGBT $\lambda_{\text{Paste}} = 1 \text{ W}/(\text{m}\cdot\text{K}) / \lambda_{\text{grease}} = 1 \text{ W}/(\text{m}\cdot\text{K})$	R_{thCH}		0.081		K/W
Temperature under switching conditions		$T_{vj \text{ op}}$	-40		150	$^{\circ}\text{C}$
Turn-on delay time, inductive load	$I_C = 40 \text{ A}, V_{CE} = 600 \text{ V}$ $V_{GE} = -15 / 15 \text{ V},$ $R_G = 10\Omega$ $T_{vj} = 25^{\circ}\text{C}$	$t_{d \text{ on}}$		85		ns
Rise time, inductive load		t_r		50		ns
Turn-off delay time, inductive load		$t_{d \text{ off}}$		200		ns
Fall time, inductive load		t_f		70		ns
Turn-on energy loss per pulse		E_{on}		4.3		mJ
Turn-off energy loss per pulse		E_{off}		1.2		mJ

Diode, Inverter Maximum Rated Values

Parameter	Conditions	Symbol	Values	Units
Repetitive peak reverse voltage	$T_{vj} = 25^{\circ}\text{C}$	VRRM	1200	V
Continuous DC forward current		IF	40	A
Repetitive peak forward current	$t_p = 1 \text{ ms}$	IFRM	80	A

Characteristic Values

Parameter	Conditions	Symbol	Values			Units
			Min.	Typ.	Max.	
Forward voltage	$I_F = 40 \text{ A}, V_{GE} = 0 \text{ V}$ $T_{vj} = 25^{\circ}\text{C}$ $T_{vj} = 150^{\circ}\text{C}$	V_F		2.3 2.5		V
Peak reverse recovery current	$I_F = 40 \text{ A}, -d_{IF}/d_t = 600 \text{ A}/\mu\text{s}$ $V_R = 600 \text{ V}, V_{GE} = -15 \text{ V}$ $T_{vj} = 25^{\circ}\text{C}$ $T_{vj} = 150^{\circ}\text{C}$	I_{RM}		160 291		A
Recovered charge		Qrr		1.9 3.9		μC
Reverse recovery energy		E_{rec}		2.1 3.4		mJ
Thermal resistance, junction to case	per diode	R_{thJC}			1.18	K/W
Thermal resistance, case to heatsink	per diode $I_{Paste} = 1 \text{ W}/(\text{m}\cdot\text{K}) / I_{grease} = 1 \text{ W}/(\text{m}\cdot\text{K})$	R_{thCH}		0.12		K/W
Temperature under switching conditions		$T_{vj op}$	-40		150	$^{\circ}\text{C}$

Module Characteristic Values

Parameter	Conditions	Symbol	Values	Units
Isolation test voltage	RMS, $f = 50 \text{ Hz}, t = 1 \text{ min.}$	VISOL	2.5	kV
Internal isolation	basic insulation (class 1, IEC 61140)		Al_2O_3	
Storage temperature			-40-125	$^{\circ}\text{C}$
Torque	To heatsink(M6) To terminal(M5)	M	3-5 2.5-5	Nm
Comperative tracking index		CTI	>200	

Fig. 1 Output characteristics

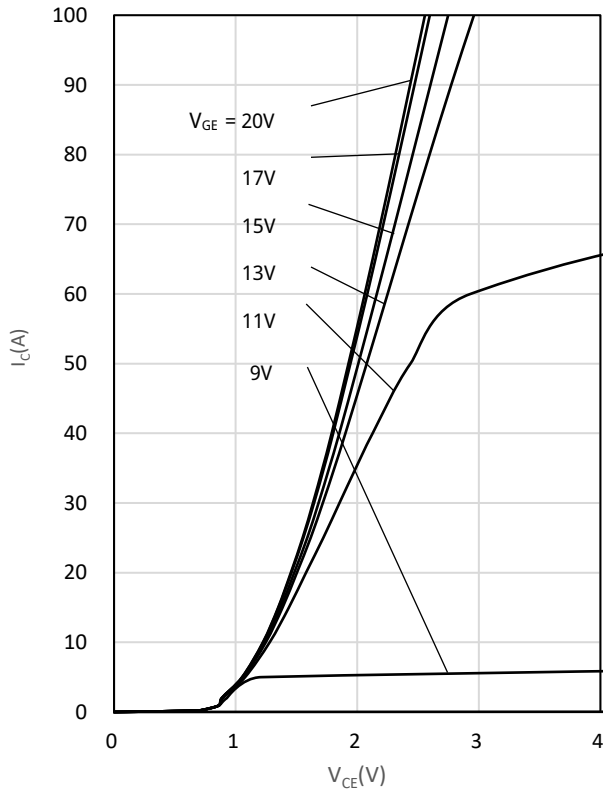

Fig. 2 Saturation voltage characteristics

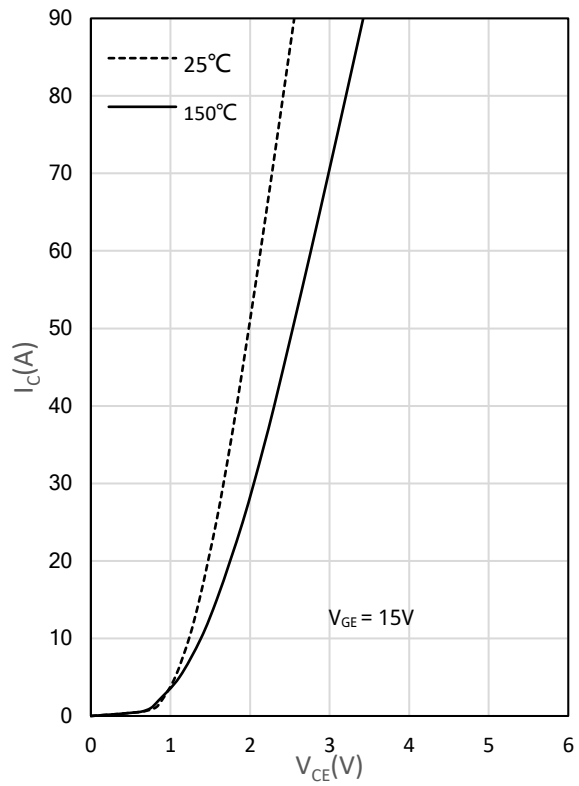

Fig. 3 Gate charge characteristics

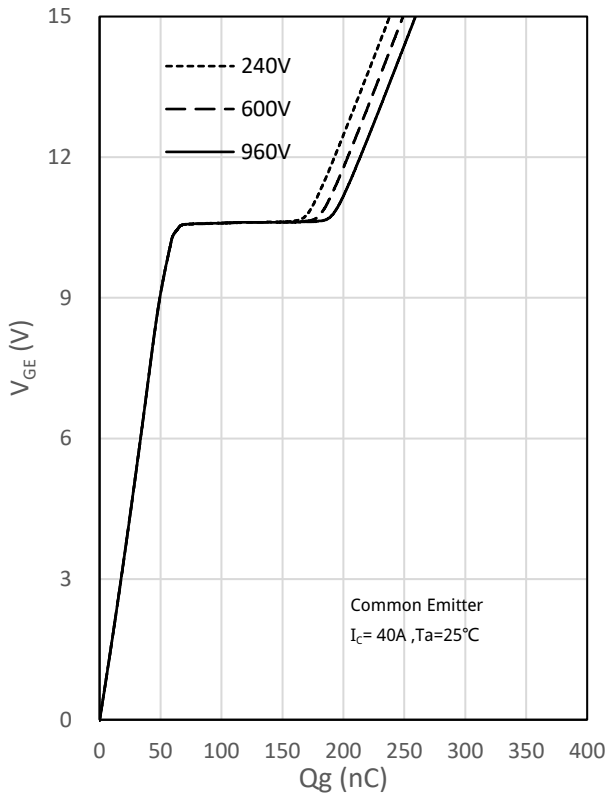

Fig. 4 Capacitance characteristics

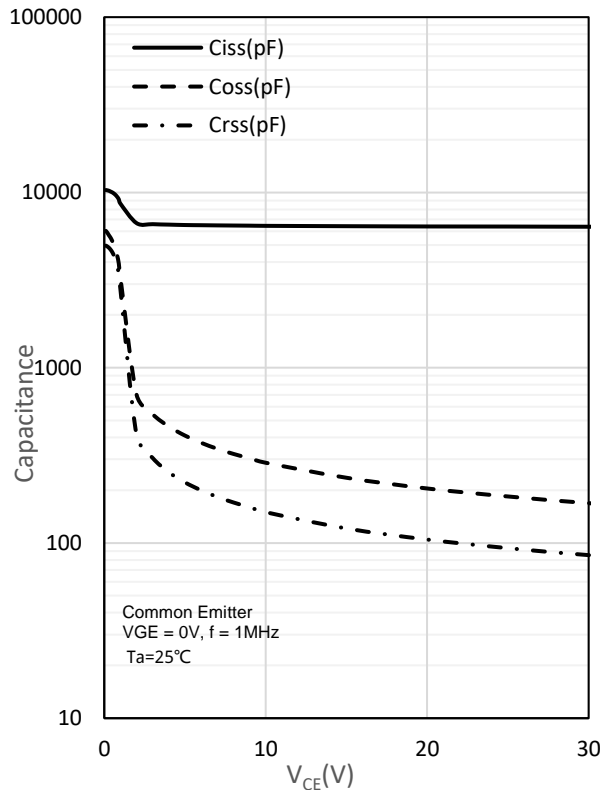

Fig. 5 Switching times vs. gate resistor

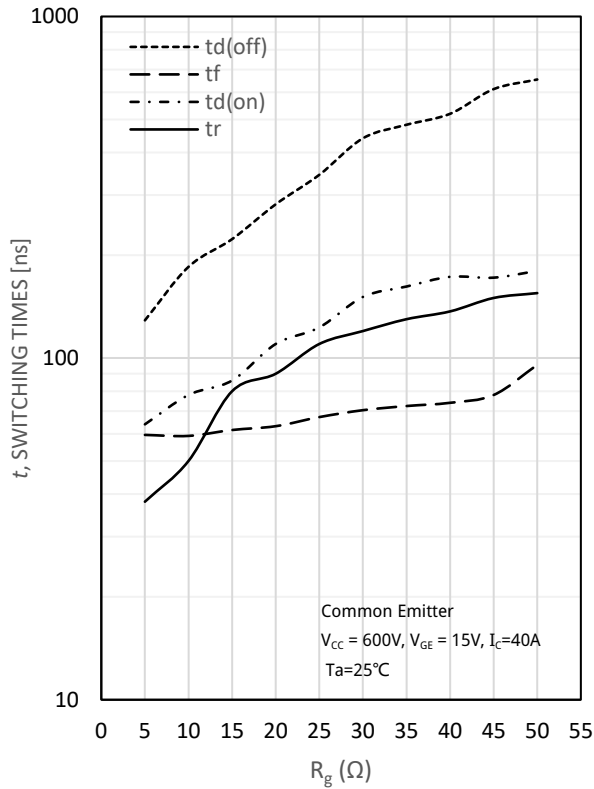

Fig. 6 Switching times vs. collector current

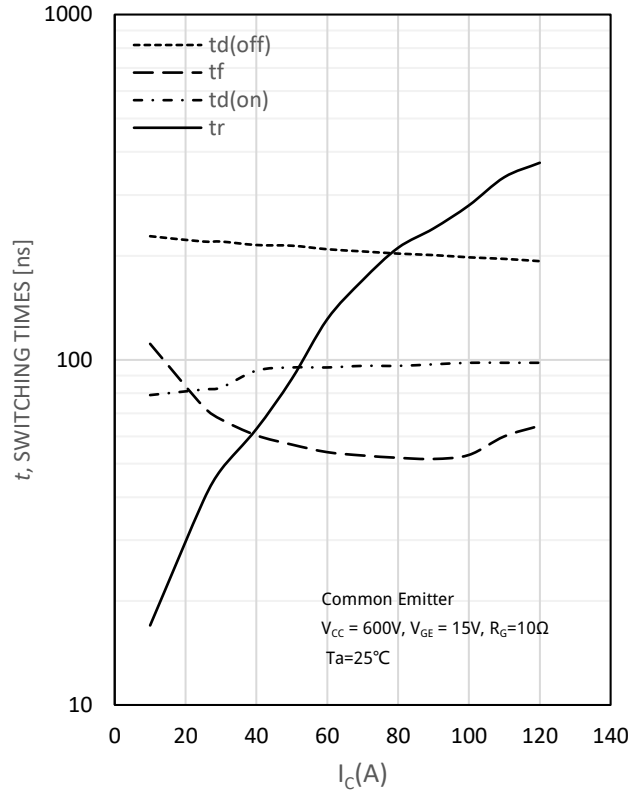

Fig. 7 Switching loss vs. gate resistor

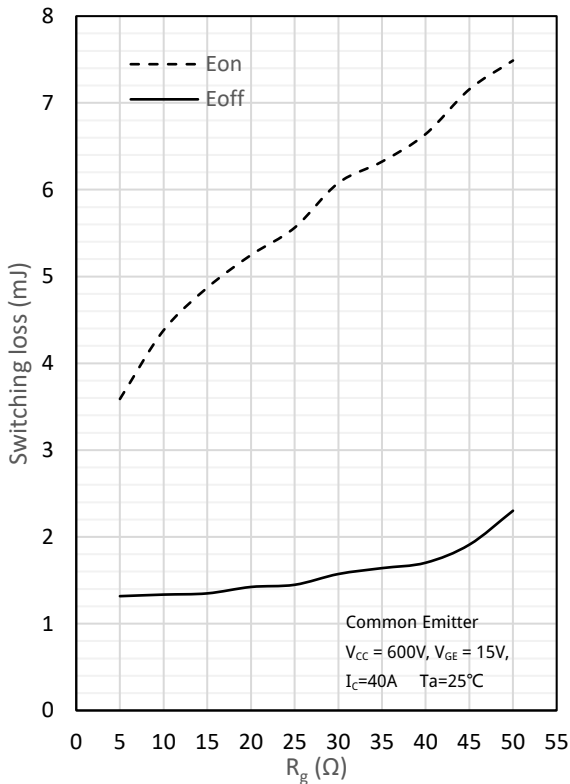
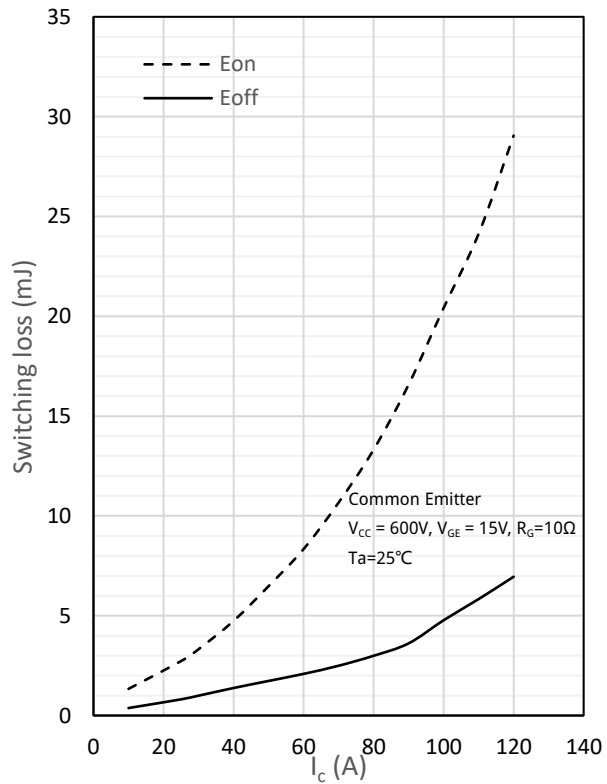
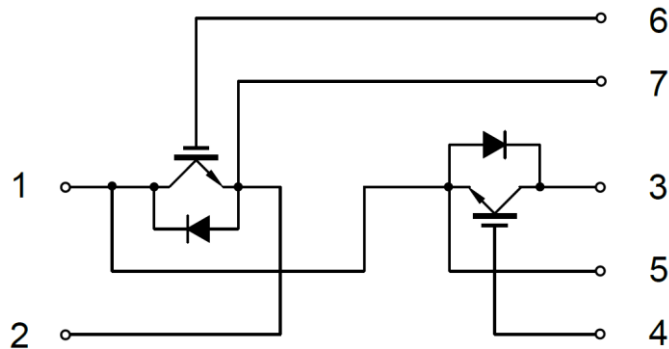

Fig. 8 Switching loss vs. collector current



Circuit diagram



Package outlines (mm)

